

Submerged Arc Components

Issued June 2009 • Index No. AY/12.0

Submerged
Arc Welding 

Quick Specs

Heavy Industrial Applications

Railcar
Shipbuilding
Heavy Fabrication
Pipe Industry
Pressure Vessel

Processes

Submerged Arc (SAW)

The Power of Blue.®

HDC 1500 DX Controller

Adaptable DC, CV controller for use in Sub Arc applications.



Sub Arc DC 650

The powerful Sub Arc DC power sources provide outstanding versatility, plus the endurance and high amperage output to handle the biggest heavy industrial applications.



Look no further than Miller to find your industry's Sub Arc welding solutions —featuring the flexible HDC 1500 controllers and Sub Arc DC series! We offer complete systems that can make you more productive and help lower your weld costs with less power consumption, increased deposition rates, and faster travel speeds!

TRUE BLUE
3YR. WARRANTY

3 years — parts and labor; original main power rectifier parts are warranted for 5 years. Reliability built into each controller.

MADE IN **USA**
APPLETON, WI **USA**



Miller Electric Mfg. Co.
An Illinois Tool Works Company
1635 West Spencer Street
Appleton, WI 54914 USA

Equipment Sales US and Canada
Phone: 866-931-9730
FAX: 800-637-2315
International Phone: 920-735-4554
International FAX: 920-735-4125

Web Site
www.MillerWelds.com



HDC 1500 A and 1500 DX Controllers



HDC 1500 A (Analog Controller)

Internal terminal strip is able to integrate with positioners, sidebeams, turning rolls and other peripheral equipment.



HDC 1500 DX (Digital Controller)

Specifications (Subject to change without notice.)



Controller	Type of Input from Welding Power Source	Welding Power Source Type	Weld Voltage and Amperage Capacity (DC)	Dimensions	Weight
HDC 1500 A	Single-phase 115 VAC, 3.5 Amps, 50/60 Hz	Constant Current (CC), Constant Voltage (CV), DC, with Remote Contactor and Output Control Capabilities	0–60 V 0–1500 A	H: 7 in (178 mm) W: 11-1/4 in (286 mm) D: 11-1/2 in (292 mm)	18 lb (8.2 kg)
HDC 1500 DX	Single-phase 115 VAC, 3.5 Amps, 50/60 Hz	Constant Voltage (CV), DC, with Remote Contactor and Output Control Capabilities	0–100 V 0–1500 A		

(Without CE) certified to both the Canadian and U.S. Standards for welding equipment.

50/60 Hz models with CE Specifications are manufactured according to the Standard IEC-60974-5.

HDC 1500 A and 1500 DX Control Panels

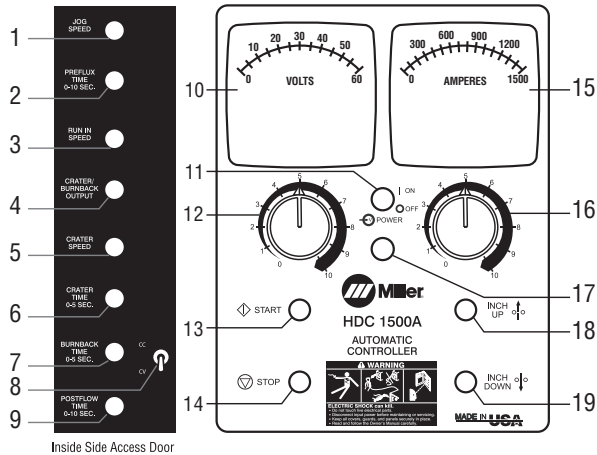

HDC 1500 A (Analog Controller)

- 1. Jog Speed
- 2. Preflux Time 0–10 Seconds
- 3. Run-In Speed
- 4. Crater/Burnback Output
- 5. Crater Speed
- 6. Crater Time 0–5 Seconds
- 7. Burnback Time 0–5 Seconds
- 8. CC/CV Switch
- 9. Postflow Time 0–10 Seconds
- 10. Voltage Meter
- 11. Power Switch
- 12. Output Control Knob
- 13. Start Button
- 14. Stop Button
- 15. Amperage Meter
- 16. Wire Feed Speed Control Knob
- 17. Indicator Light
- 18. Wire Inch Up
- 19. Wire Inch Down

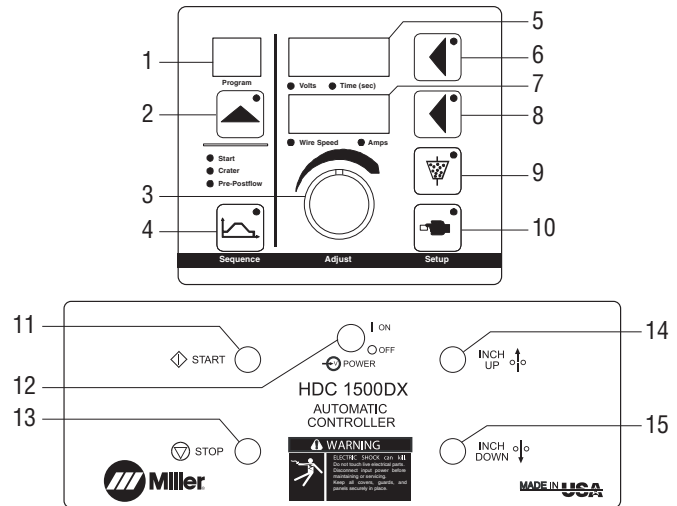

HDC 1500 DX (Digital Controller)

- 1. Program Display
- 2. Program Push Button
- 3. Adjust Control
- 4. Sequence Push Button
- 5. Upper Display
- 6. Upper Display Push Button
- 7. Lower Display
- 8. Lower Display Push Button
- 9. Flux Push Button
- 10. Setup Push Button
- 11. Start Button
- 12. Power Switch
- 13. Stop Button
- 14. Wire Inch Up
- 15. Wire Inch Down

Miller Tractor

The Miller Tractor is a highly flexible self-contained welding unit comprised of a travel system and a variety of quality engineered components designed to produce precision, high-quality Submerged Arc welds.

Tractor comes complete with a main mounting mast and handle assembly, mounting arm for one wire reel, vertical and horizontal 4 x 4 in slides, control support arm and one set of two adjustable guide roll arms.

The friction drive heavy-duty travel carriage utilizes a positive chain drive powering four rubber-tired wheels with a closed-loop tach feedback for accurate speed control. A manual clutch enables freewheeling movement of the carriage. Remote pendant control box houses forward/stop/reverse switch and infinitely variable 4-turn speed potentiometer as well as LED display in IPM or cm/min. Available with either the HDC 1500 DX or 1500 A (see page 2).



Package Includes:

- Tractor
- HDC weld controller
- RAD-400 drive motor
- 25 lb (11.3 kg) capacity flux hopper with valve
- Wire reel
- OBT 600 Torch
- Tractor guide rolls
- Remote start/stop control
- Wire straightener

Note: Order drive rolls and contact tips separately and extension cords of appropriate length.

Specifications (Subject to change without notice.)

Wire Feed Speed	Wire Size Range	Max. Incline	Gun Positioning Slides	Supply Voltage (from HDC 1500)	Drive Motor	Max. Spool Size Capacity	Travel Speed	Dimensions*	Weight
20–400 IPM (51–1016 cm/min)	3/32–5/32 in (2.4–4.0 mm)	30° depending on mounting configuration	4 in (101.6 mm) vertical and horizontal stroke	115 VAC, 1-Phase, 50/60 Hz, 200 watts	24 VDC permanent magnet gear motor	60 lb (27 kg)	4–66 IPM (10–168 cm/min)	H: 43-3/8 in (1102 mm) D: 35-1/2 in (903 mm)	162 lb (73 kg) without flux/wire

*Width will vary depending on how system is configured.

Tractor Speed Control Panel and Line Drawings

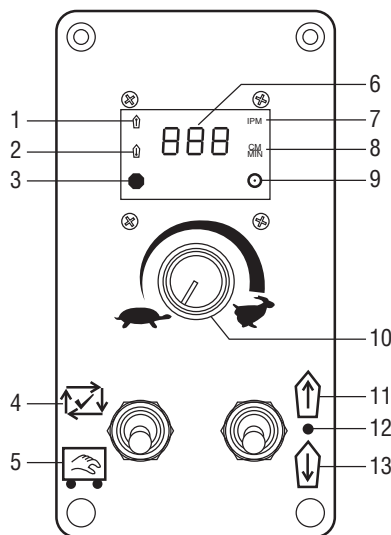

1. Forward Motion Commanded Indicator
2. Reverse Motion Commanded Indicator
3. Hold (Stop) Mode Active Indicator
4. Auto Enable Mode
5. Manual Carriage Mode

6. Speed and Parameter Display
7. Speed Display Indicator
8. Speed Display Indicator (Calibrated in Centimeters per Minute)

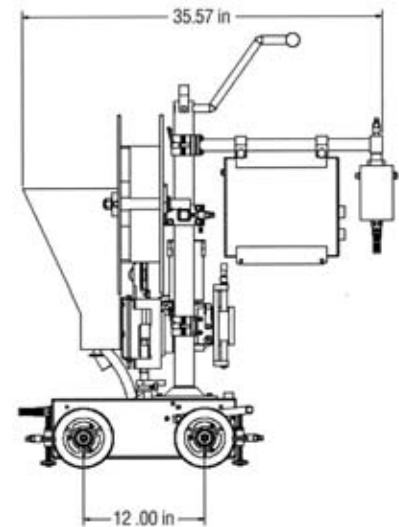

9. Programming Mode Indicator (Flashing)
10. Speed Adjustment
11. Command Forward Motion
12. Neutral
13. Command Reverse Motion

Sub Arc DC 650/800 and Sub Arc DC 1000/1250 Power Sources

DC multiprocess capability, versatility and outstanding performance in SAW process.

Line voltage compensation keeps welding parameters constant even when input voltages change $\pm 10\%$. Eliminates need to change welding parameters throughout the day.

Fan-On-Demand™ cooling system only works when needed reducing energy usage and noise.

Fully populated terminal strip for sense leads and remote on/off.



15 amp 115 VAC duplex receptacle allows operators the flexibility to run grinders, drills, coolers, etc. from the power source without the need for additional 115 VAC power in the weld area.

Power efficient for exceptional value and return on your investment.

Digital meters for presetting and monitoring welding voltage or amperage.

Remote control capability allows operators fine tuning capability at an extended distance, with the HDC 1500 Controllers.

See Literature Index No. DC/19.8 for additional information.

Specifications (Subject to change without notice.)



Model	Rated Output	Mode	Amperage/ Voltage Range	Max. Open-Circuit Voltage*	Amps Input at Rated Output, 3-Phase, 50/60 Hz								Dimensions	Weight	
					230 V	380 V	400 V	440 V	460 V	520 V	575 V	KVA			KW
Sub Arc DC 650/800	650 A at 44 VDC, 100% Duty Cycle	CC	50–815 A	72 VDC	126	77	73	66	63	54	50.4	50	34.8	H: 27-1/4 in (692 mm) including lift eye W: 22-1/4 in (565 mm) D: 36 in (914 mm) including strain relief	545 lb (247 kg)
		CV	10–65 V		3.8**	1.9**	1.8**	1.6**	1.9**	1.1**	1.4**	1.52**	0.76**		
Sub Arc DC 1000/1250	1000 A at 44 VDC, 100% Duty Cycle	CC	100–1250 A	66 VDC	180	109	104	94	90		72	73	53		
		CV	10–60 V		5.8**	5.2**	5.0**	4.5**	2.9**		2.4**	3.2**	0.5**		

*Open-circuit voltages in CV mode are factory set at values less than indicated for CC. **While idling.

Certified to both the Canadian and U.S. Standards for welding equipment.

50/60 Hz models with CE Specifications are manufactured according to the Standard IEC-60974-1.

Control Panels

1. Arc Force (DIG) Control
2. Remote Amperage/Voltage Control Switch
3. Output Switch (Contactor)
4. Process Switch
5. Digital Meters
6. Amperage/Voltage Adjustment Control
7. High Temperature Shutdown Indicator Light
8. Power Switch with Indicator Light

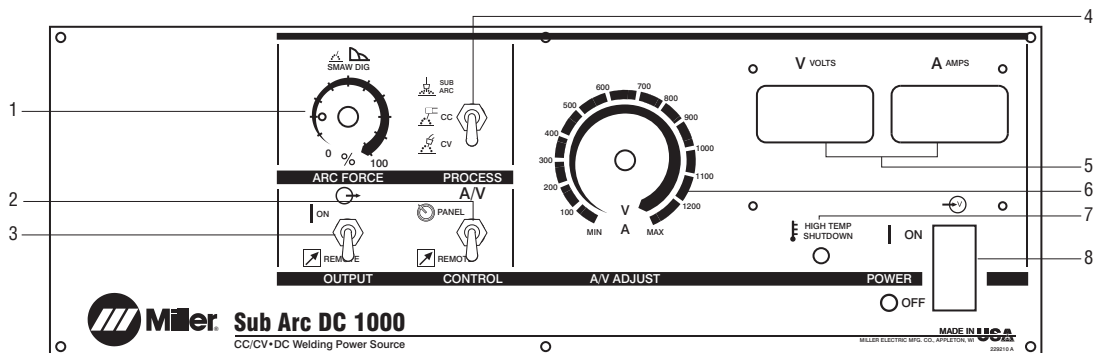
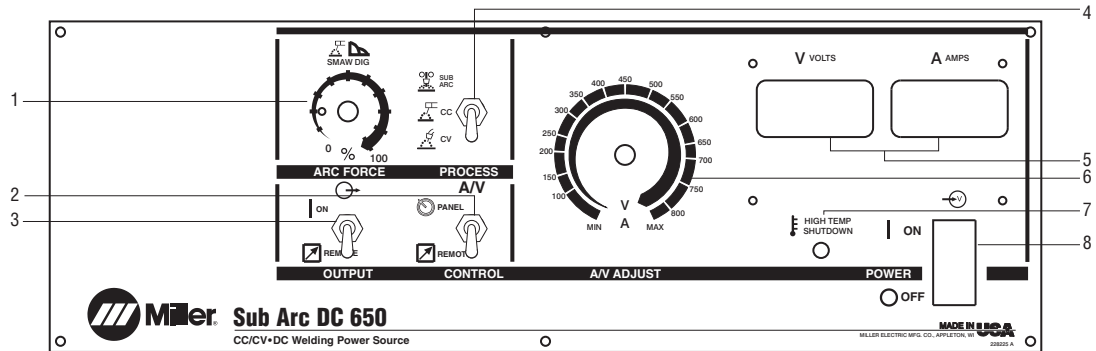

Components and Accessories

RAD Wire Drive Assemblies

Miller offers either standard- or high-speed 115-volt heavy-duty wire drive assemblies. The RAD-400 has a wire feed speed range of 20–400 inches per minute (0.5–10 MPM). The RAD-780 has a wire feed speed range of 30–780 inches per minute (0.7–19.8 MPM). Included adapter plate allows mounting to 2-1/2, 4-1/4, and 4-5/8 inch bolt-hole patterns.



RAD-400
#195 265
Standard-speed, right-angle wire drive assembly.

RAD-780
#195 266
High-speed, right-angle wire drive assembly.

Included adapter plate allows mounting to 2-1/2, 4-1/4, and 4-5/8 inch bolt hole patterns.

Drive Rolls

“V” Knurled drive rolls for use with hard-shelled cored wires.

- 1/16 in (1.5 mm) #132 955
- 5/64 in (2.0 mm) #132 960
- 3/32 in (2.4 mm) #132 961
- 7/64 in (2.8 mm) #132 962
- 1/8 in (3.2 mm) #132 963
- 5/32 in (3.9 mm) #193 700
- 3/16 in (4.7 mm) #193 701
- 7/32 in (5.5 mm) #193 702



Flux Handling Equipment



Flux Hopper with Valve
#194 775

Flux hopper with automatic flux valve will carry 25 lb of flux. The opening is sized to allow hook-up of any flux-hopper-mounted recovery system. A slag screen is also provided.

Flux Recovery Systems

- Weld Engineering 1-508-842-2224
- American Vacuum 1-800-321-2849
- Invincible 1-800-282-6999

Submerged Arc Torches

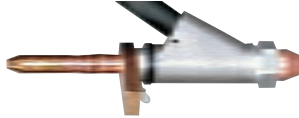

OBT 600 #043 923
600 amp, 100 percent duty cycle torch with concentric flux flow nozzle. Can be used with 1/16–7/32 in (1.6–5.5 mm) wire.

OBT 600 Torch Body Extensions

- 1 inch #043 967
- 2 inch #043 969
- 4 inch #043 973
- 6 inch #043 975



OBT 1200 #043 900
1200 amp, 100 percent duty cycle torch with concentric flux flow nozzle. Can be used with 1/16–7/32 in (1.6–5.5 mm) wire. OBT 1200 features a replaceable breakaway adapter end to prevent costly damage should torch run into an obstruction.

OBT 1200 Torch Body Extension #043 981

Overall length with extension is 9 in. Actual length of extension is 8-1/2 in.

Torch Contact Tips

Wire Size	OBT 600	OBT 1200
1/16 in (1.6 mm)	#192 700	#192 141
5/64 in (2.0 mm)	#192 701	#199 026
3/32 in (2.4 mm)	#192 702	#192 142
7/64 in (2.8 mm)	#192 703	#200 771
1/8 in (3.2 mm)	#192 704	#192 143
5/32 in (4.0 mm)	#192 705	#192 144
3/16 in (4.8 mm)	#192 706	#192 136
7/32 in (5.6 mm)	#192 707	#200 756

Accessories

Wire Straightener #199 733

For RAD-400 (standard-speed) or RAD-780 (high-speed) wire drive assembly. For wires 1/16–7/32 in (1.6–5.6 mm).

Light-Duty Cross Slide #195 411

Allows 6 inches of travel adjustment. Two units can be stacked to provide vertical and horizontal movement. **Not recommended for tandem.**

Heavy-Duty Cross Slide #300 482

One-inch diameter, precision, hardened and ground guide rods provide a perfect path for the sealed linear bushings, and smooth accurate movement of the weld head. Allows for 6 inches of travel adjustment and has a load capacity of 200 lb. **Recommended for tandem.**



Wire Reel

#108 008
For 60 lb (27 kg) coil of wire. Requires Spool Support Assembly (#119 438).

Spool Support Assembly #119 438

For 60 lb (27 kg) wire reel.

Cable Kit for HDC 1500 Controllers

#195 308

Includes 30 ft (9 m) 14-pin interconnect cable and 10 ft (3 m) motor cable.

Motor Extension Cable #195 342

25 ft (7.6 m) extension for the motor cable.

Extension Cables

25 ft (7.6 m) #043 725
50 ft (15 m) #043 726
75 ft (23 m) #043 727
14-pin welding power source control cable. Extends distance between power source and controller.

Questions and Answers

Q. Does Miller have a full offering for the Submerged Arc process?

Miller offers weld controllers, wire drive assembly, power sources, flux hoppers and torches all developed together to offer you the best performance from a system approach. When used in conjunction with each other Miller can assure you that these items have been tested together to optimize their performance.

Q. Can Miller Submerged Arc equipment be used with equipment other than Miller?

No: Because of the optimized performance that a Miller system offers we do not recommend mixing other manufacturers power sources, controllers or wire drive assemblies.

Q. Why do I need to use sense leads?

Sense leads are critical to obtaining correct arc voltage to optimize the system. When sense leads are not used the system supplies the pre-set voltage at the studs of the power source, not at the arc. Voltage drop in the work piece and cables is not accounted for and therefore a lower voltage than what is preset will be delivered to the arc and can cause poor arc performance.

Q. Does it really matter where I hook the sense leads up?

Yes: The proper placement of sense leads is as important as using them. The proper placement is covered in the owner's manuals of the power sources and controllers.

Q. Why is the sense lead connection only on the power source now?

This allows the communication between the power source and control to be faster and more accurate. This also promotes good starts.

Q. What power sources are recommended to go along with the Miller controls?

DC Power Sources	Part Number
Sub Arc DC 650	#907 338
Sub Arc DC 800	#907 344
Sub Arc DC 1000	#907 342
Sub Arc DC 1250	#907 343 with CE

Q. Why are the Deltaweld® and Invision™ no longer recommended?

They do not have the capability to hook up sense leads externally for accurate arc voltage. The power sources mentioned above have a terminal strip to accommodate this sense lead hookup.

Q. What is a RAD-400 and RAD-780?

The RAD stands for right angle drive and it is Miller's wire drive assembly for wire diameters from 1/16–1/4 in. The 400 and 780 represent the highest wire feed speed of each motor. The RAD-400 is recommended for most sub arc applications using wires larger than 5/64 in (2 mm).

Q. Does Miller Electric have fluxes and wire for Submerged Arc welding?

No they do not. Hobart offers a line of wires and fluxes for SAW Welding which work with the Miller Submerged Arc equipment. If a flux and wire combination is being used with current equipment, that same combination can be used with the Miller Electric equipment. If you are looking for a new flux and wire, or increased deposition is a consideration, then the Hobart/Tri-Mark consumables should be considered. Please contact them through your local distributor or call Hobart at 937-332-5135 and ask for their recommendations.

Q. Can I use the Miller flux hopper with preheated flux?

Yes. We have improved the design of the flux hopper to be able to accommodate hot flux whether preheated or reclaiming directly after the weld. The hopper also comes standard with an electric valve that can be controlled manually or from the controller.

Typical Installation

*Sense leads connected to the power source are required for optimal performance.

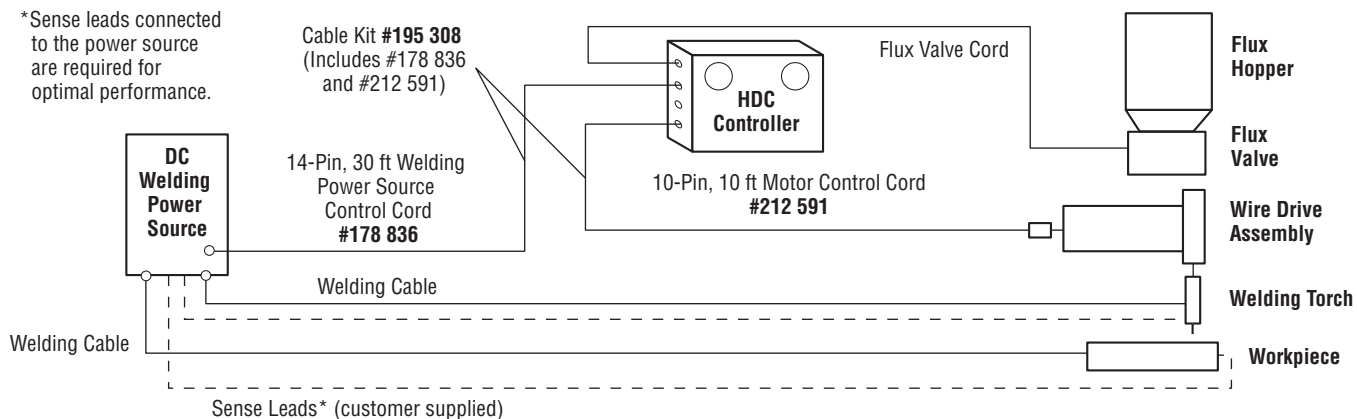

Recommended Power Sources

Sub Arc DC Series	See Lit. Index No. DC/19.8
Sub Arc DC 650	#907 338 230/460/575 V, 60 Hz
Sub Arc DC 800	#907 344 380/400/440 V, 50/60 Hz w/CE
Sub Arc DC 1000	#907 342 230/460/575 V, 60 Hz
Sub Arc DC 1250	#907 343 380/400/440 V, 50/60 Hz w/CE

Ordering Information

Equipment and Options	Stock No.	Description	Qty.	Price
HDC 1500 A	#300 439			
HDC 1500 DX	#300 438			
Miller Tractor				
MT 1500 A	#951 061	With HDC 1500 A analog controller		
MT 1500 DX	#951 060	With HDC 1500 DX digital controller		
RAD Drive Motors				
RAD-400	#195 265	Standard-speed right-angle drive motor		
RAD-780	#195 266	High-speed right-angle drive motor		
Drive Rolls		See chart on page 5		
Flux Handling Equipment				
Flux Hopper with Valve	#194 775	25 lb capacity		
Flux Recovery Systems		See page 5		
Torches				
OBT 600	#043 923	600 amp, 100% duty cycle, air-cooled		
OBT 600 Torch Body Extensions	#043 967 #043 969 #043 973 #043 975	1 inch 2 inch 4 inch 6 inch		
OBT 1200	#043 900	1200 amp, 100% duty cycle, air-cooled		
OBT 1200 Torch Body Extension	#043 981	9 inch		
Contact Tips		See chart on page 5		
Accessories				
Wire Straightener	#199 733	For 1/16–7/32 in (1.6–5.6 mm) wire		
Light-Duty Cross Slide	#195 411	Provides 6-in travel adjustment, load capacity of 150 lb		
Heavy-Duty Cross Slide	#300 482	Provides 6-in travel adjustment, load capacity of 250 lb		
Wire Reel	#108 008	For 60 lb (27 kg) coil, requires Spool Support Assembly #119 438		
Spool Support Assembly	#119 438	Support for 60 lb reels		
Cable Kit for HDC 1500 Controllers	#195 308	Includes 30 ft (9 m) 14-pin interconnect cable and 10 ft (3 m) motor cable		
Motor Extension Cable	#195 342	25 ft (7.6 m) motor cable extension		
Extension Cables	#043 725 #043 726 #043 727	25 ft (7.6 m), 14-pin 50 ft (15.2 m), 14-pin 75 ft (22.9 m), 14-pin		

Date:

Total Quoted Price:



Distributed by: